

Data Sheet



Article number: 12521800030100

Description: KLEE-coil 521 800 030.100
M3 Hardened, zinc-pl. & chr. yellow

Measures

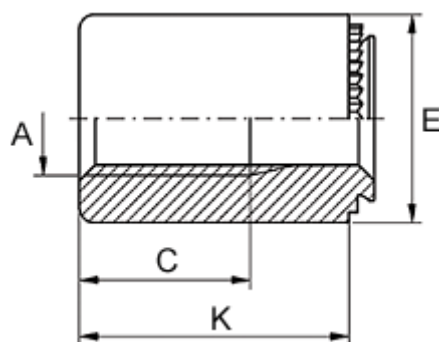

Female thread A	= M3
Height K	= 21
Min distance to edge	= 4.0
Outer diameter E	= 7
Plate thickness	= 0.8 to 1.0
Recommended bore diameter +0.05	= 5.00
Thread length	= 8.0